

江西省晶能半导体有限公司
JiangXi LatticePower Semiconductor Corporation

产 品 规 格 书
Specification

产品名称 Product Name: IBP85100K-35

产品型号 Product P/N: IB-P85-100K-50-RM-AD2

客 户 Client name: 海康威视

客户料号 Client P/N: _____

版 本 号 Version No.: V004

日 期 Sending Date: 2023.06.16

客户承认栏 Client Approval	
核准 Approval	确认 Audit

 ROHS REACH

制定 Confirmation: _____ 审核 Approval: _____

工厂地址:江西省南昌市高新区艾溪湖北路 699 号

Address: No.699 Aixihu North Road, Nanchang, Jiangxi Province, China

目录

Contents

1、特点 Features	1
2、应用 Applications.....	1
3、特征性能 Characteristic performance.....	2
4、产品代码 Product Order Code.....	3
5、分档规则 Bin Regulations	4
6、光电特性图 The Photoelectric Characteristics Graph	5
7、产品尺寸&产品电路 Product Size & Product Circuit	9
8、回流焊特性 Reflow Soldering Characteristics	10
9、卷轴 Reel Dimensions.....	11
10、可靠性验证 Reliability	12
11、注意事项 Cautions.....	14

1、特点 Features

- ◆ 三安 20mil 红外芯片
San' an 20mil IR Chip
- ◆ 金线（绑线）：金纯度>99%
Gold wire (Binding wire): Gold purity> 99%
- ◆ Al₂O₃ 陶瓷封装
Al₂O₃Ceramic Substrate package
- ◆ 透镜材质：硅胶
Lens Material: Silicone
- ◆ 尺寸：3.5mm*3.5mm*2.2mm
Size: 3.5mm*3.5mm*2.2mm
- ◆ 适于 SMT 贴片
Compatible with SMT
- ◆ 设计角度： 100°
Design Angle: 100°
- ◆ 发光角度 50%: 50°
Viewing Angle 50%: 50°
- ◆ 包装：最大 1000 颗/卷
Package: Max: 1000pcs /reel

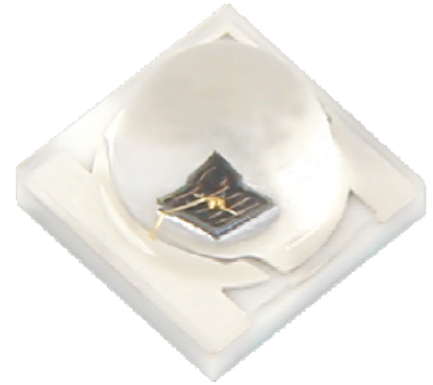

2、应用 Applications

安防监控	Security monitoring
红外摄像	Infrared camera
红外测距	Infrared ranging



3、特征性能 Characteristic performance

a) 绝对最大额定值 Absolute Maximum Ratings

参数 Parameter	符号 Symbol	最大参数值 Maximum Rating	单位 Unit
电流 Forward Current (DC)	I_F	500	mA
功率 Power Dissipation	P	1	W
结温 (DC 模式) LED Junction Temperature (DC mode)	T_j	125	°C
工作温度 Operating Temperature Range	T_{opr}	-40~85	°C
存储温度 Storage Temperature	T_{stg}	-40~105	°C

b) 光电参数 Photoelectric parameters ($T_{\text{solder pad}}=25\text{ °C}$, $I_F=250\text{mA}$)

项目 Item	符号 Symbol	最小值 Min.	典型值 Typ.	最大值 Max.	单位 Unit
总辐射能量 Total Radiated Power	Φ_e	150	230	300	mW
正向电压 Forward Voltage	V_F	1.4	1.6	2.0	V
热阻 Thermal Resistance	R_{th}	----	9	13	°C/W
设计角度 Design Angle		----	100	----	°
发光角度 Viewing Angle	$2\theta_{1/2}$	----	50	----	°
峰值波长 Peak Wavelength	λ_p	840	850	870	nm
半波宽 Half wave width	$\Delta\lambda$	----	50	----	nm

备注 Notes :

◇ 热阻指芯片结到焊盘焊点的热阻。焊盘散热条件为 20*20mm 六角梅花板，厚度 1.5mm，导热系数为 1 W/mk。

Thermal resistance refers to the thermal resistance of the chip junction to the solder joint of the disc.

The heat dissipation condition of the welding disc is 20*20mm hexagonal plum plate with a thickness of 1.5mm and a thermal conductivity of 1 W/mk

5、分档规则 Bin Regulations

a) 峰值波长分档 Peak Wavelength Groups (T solder pad = 25°C, I_F = 250mA)

代码 Group Code	最小值 Min.	最大值 Max.
P85	840	870

备注 Notes :

◇ 峰值波长测试误差±1.5nm。

It maintains a tolerance of ±1.5nm on peak wavelength measurements.

b) 辐射功率分档 Radiation Power Groups (T solder pad = 25°C, I_F = 250mA)

代码 Group Code	最小值 Min.	最大值 Max.
RM	150	300

备注 Notes :

◇ 辐射功率测试误差±8%。

It maintains a tolerance of ±8% on Radiation Power measurements.

c) 电压分档 Voltage Groups (T solder pad = 25°C, I_F = 250mA)

代码 Group Code	最小值 Min.	最大值 Max.
AB2	1.4	1.6
AB3	1.6	1.8
AB4	1.8	2.0
AD2	1.4	2.0

备注 Notes :

◇ 电压测试误差±0.15V。

It maintains a tolerance of ±0.15V on Voltage measurements.

6、光电特性图

The Photoelectric Characteristics Graph (Ta= 25 °C)

a) 正向电流-正向电压曲线

Forward Voltage VS. Forward Current Curve

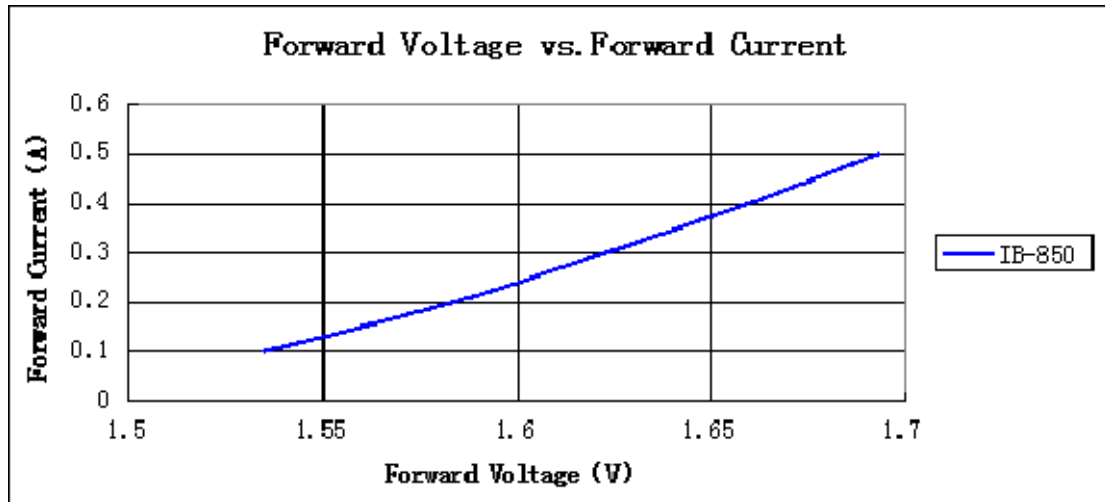

b) 辐射功率-正向电流曲线

Radiation Flux VS. Forward Current Curve

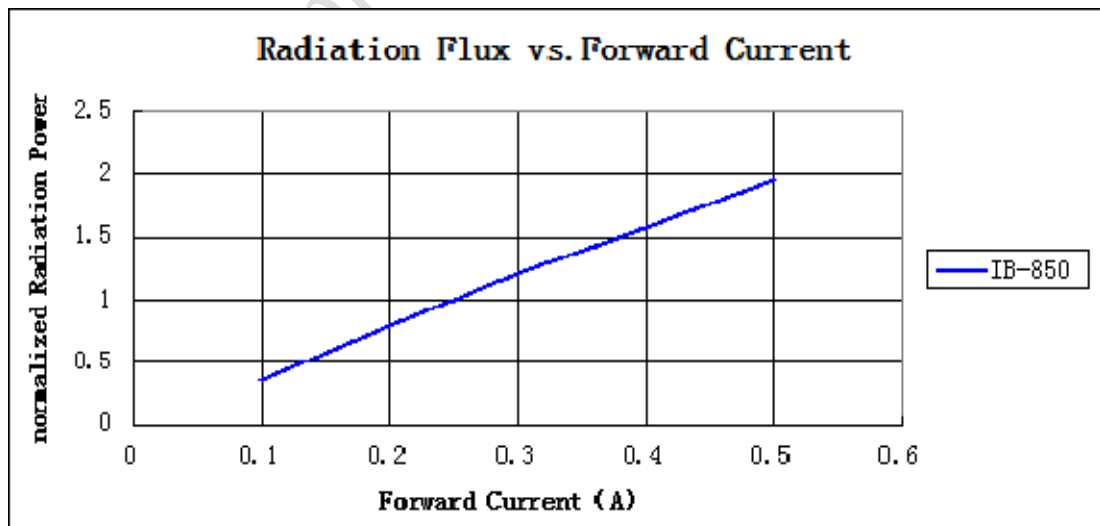

c) 相对能量-波长光谱曲线

Relative Energy Spectrum VS. Wavelength

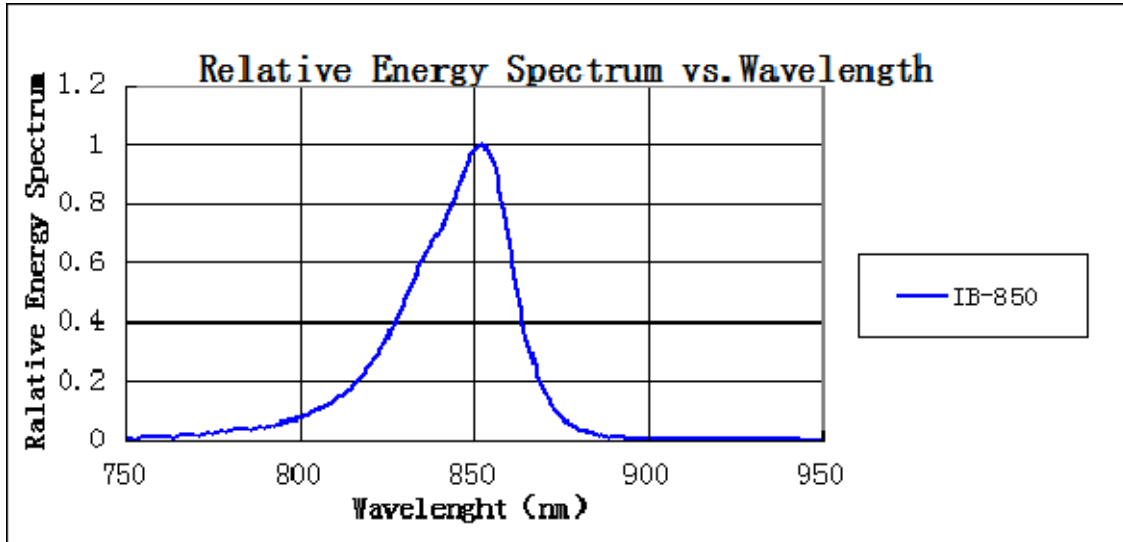

d) 相对辐射能量-环境温度曲线 ($I_F = 250\text{mA}$)

Relative Radiant Flux vs. Ambient Temperature

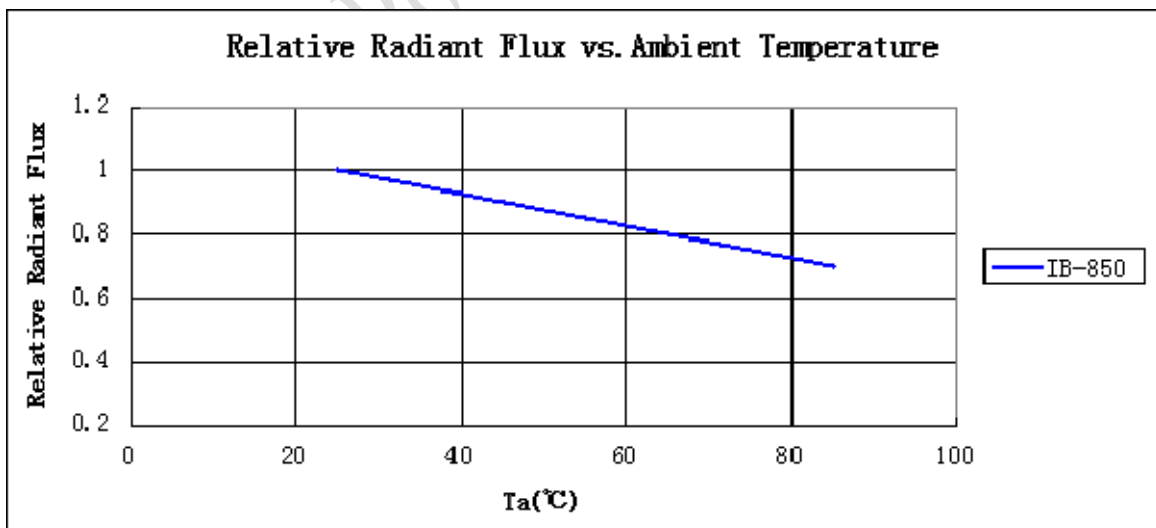

e) 正向电压-环境温度曲线 ($I_F = 250\text{mA}$)

Forward Voltage vs. Ambient Temperature

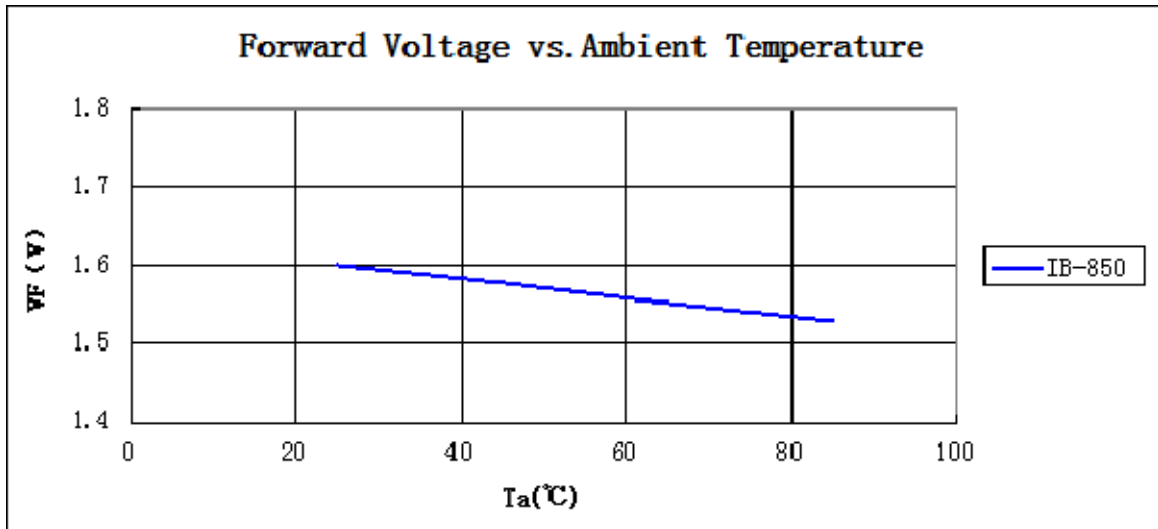

f) 最大正向电流-焊点温度曲线

Maximum Forward Current vs. Soldering Point Temperature

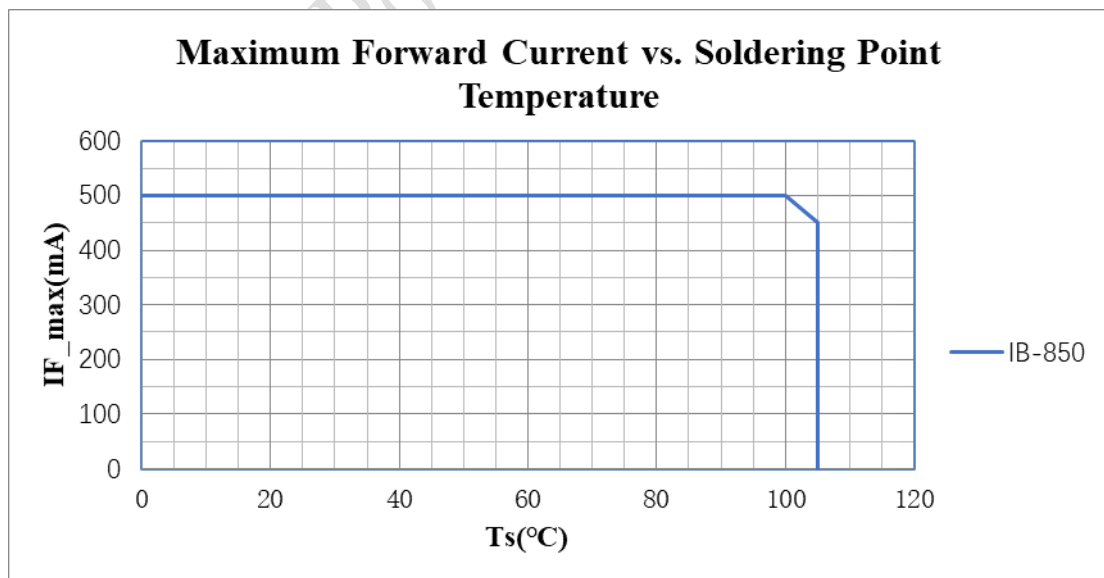

g) 空间分布

Spatial Distribution

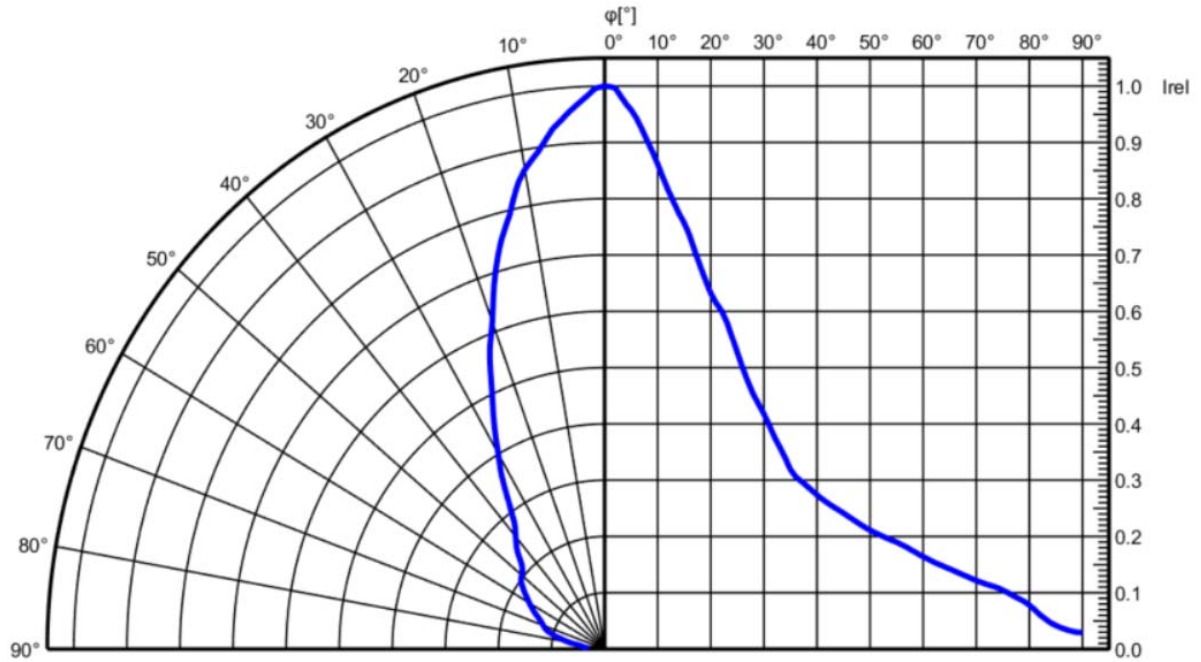

出光角度 $2\theta_{1/2}$ 50° ($2\theta_{1/5}$ 100°)
 Viewing Angle $2\theta_{1/2}$ 50° ($2\theta_{1/5}$ 100°)

7、产品尺寸&产品电路 Product Size & Product Circuit

产品尺寸 Product Dimensions:

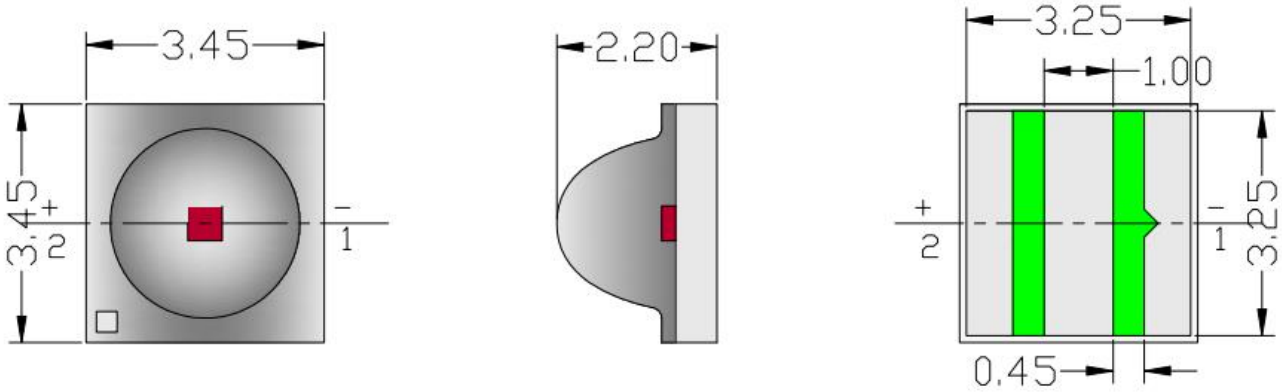

产品电路图 Product circuit diagram

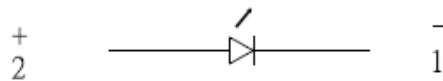

PCB 焊盘尺寸 PCB Pad Dimensions:

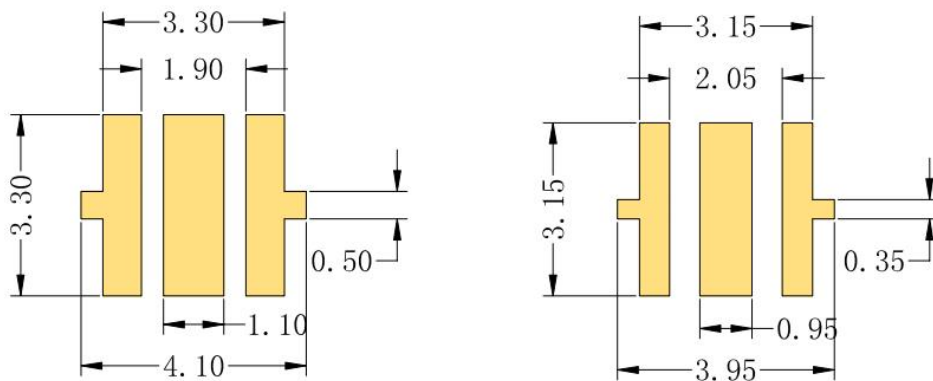

建议 PCB 焊盘

建议钢网

备注 Notes:

- ◇ 所有尺寸均以 mm 为单位
All dimensions are in millimeters
- ◇ 尺寸未标记公差按照公差 $\pm 0.15\text{mm}$ 计，尺寸图例有标记公差按照图纸计
Size is not marked in accordance with tolerance $\pm 0.15\text{mm}$ and dimension tolerances in accordance with drawings

8、回流焊特性 Reflow Soldering Characteristics

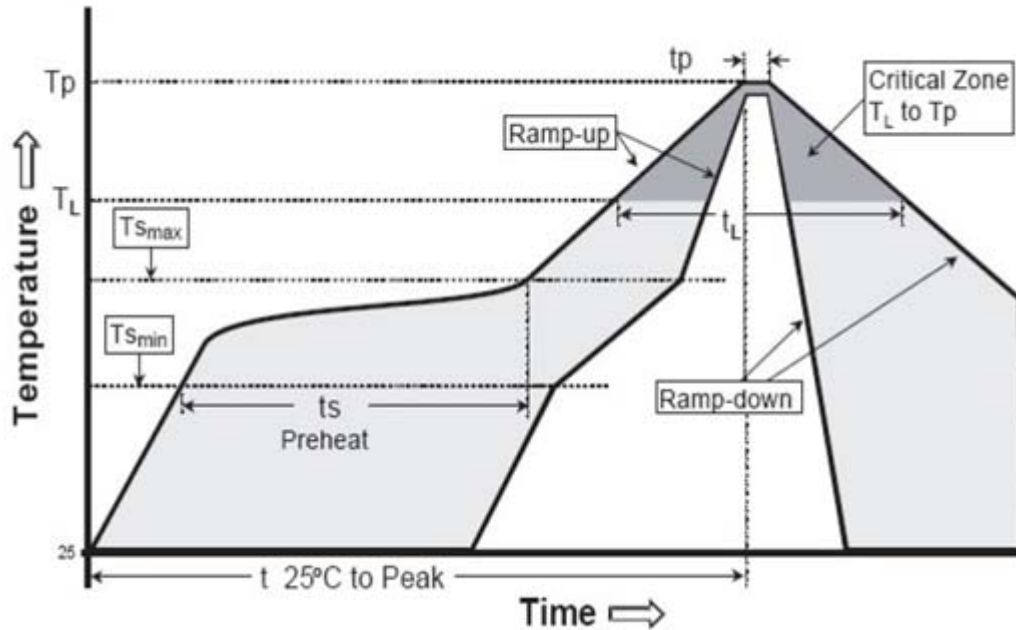

根据 EDEC-J-STD-020D 内容，参考以下内容。

Compatible with the JEDEC-J-STD-020D, using the parameters listed below.

特制参数 Profile Feature	无铅焊料 Lead-Free Solder	铅基焊料 Lead-Based Solder
平均上升速率 (Tsmmax 至 Tp) Average Ramp-Up Rate (Tsmmax to Tp)	3 °C/sec max.	3 °C/sec max.
预热: 温度最小值 (Tsmmin) Preheat: Temperature Min (Tsmmin)	150°C	100°C
预热: 最高温度 (Tsmmax) Preheat: Temperature Max (Tsmmax)	200°C	150°C
预热: 时间 (tsmin 到 tsmax) Preheat: Time (tsmin to tsmax)	60-180 secs	60-120 secs
回流温度 (TL) Time Maintained Above: Temperature (TL)	217°C	183°C
回流时间 (tL) Time Maintained Above: Time (tL)	60-150 secs	60-150 secs
峰值/分类温度 (Tp) Peak/Classification Temperature (Tp)	255 ± 5°C	215 ± 5°C
实际峰值温度 (tp) 在 5°C 以内的时间 Time Within 5°C of Actual Peak Temperature (tp)	20-40 secs	10-30 secs
降低速率 Ramp-Down Rate	5°C/sec max.	5°C/sec max.

9、 卷轴 Reel Dimensions

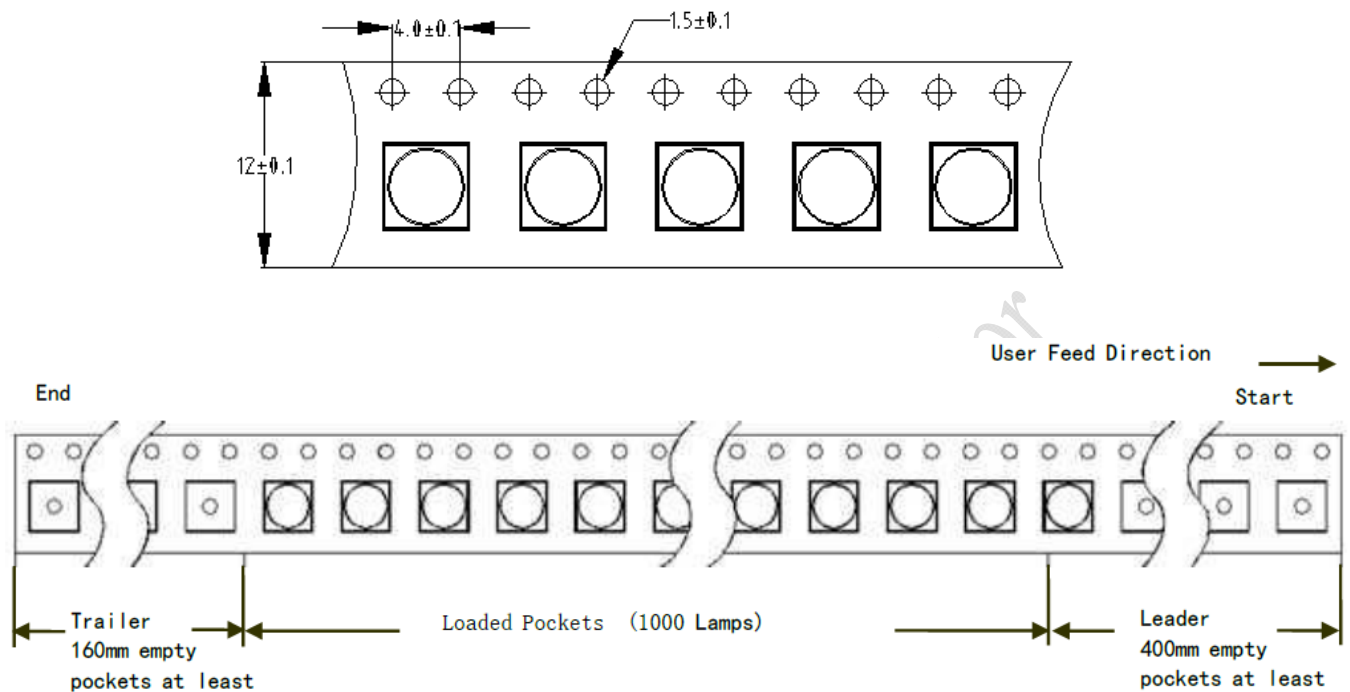

备注 Notes:

- ◇ 卷轴包装 1000pcs
Reel:1000pcs.
- ◇ 卷轴包装方法符合 IJSC0806 (连续胶带上的电子元件包装)
The tape packing method complies with IJSC0806(Packing of Electronic Components on Continuous Tapes).
- ◇ 当卷轴由于工作中断而重绕时, 载带上压力不应超过 10N, 否则 LED 可能会粘在盖带上
When the tape is rewound due to work interruptions, no more than 10N should be applied to the embossed carrier tape.
The LEDs may stick to the cover tape.

10、可靠性 Reliability

a) 测试和结果 Tests and Results

测试项目 Test Item	参考标准 Reference Standard	测试条件 Test Conditions	测试周期 Test Duration	失效标准 Failure Criteria#	失效数/测试数 Units Failed/Tested
可焊性(回流焊) Solderability(Reflow Soldering)	JEITA ED=4701 303 303A	$T_{sld}=255\pm 5^{\circ}\text{C}$, 5sec, Lead-free Solder (Sn-3.0Ag-0.5Cu)	3times	#2	0/22
高低温循环 Temperature Cycle	JEITA ED=4701 100 105	-40°C (30min)~ 25°C (5min)~ 85°C (30min)~ 25°C (5min)	100cycles	#1	0/22
高温/低温储存 High/Low Temperature Storage	JEITA ED=4701 200 201/ JEITA ED=4701 200 202	$T_A=120^{\circ}\text{C}/T_A=-40^{\circ}\text{C}$	1000h	#1	0/22
常温老化 Room Temperature Operating		$T_A=25^{\circ}\text{C}$, $I_F=500\text{mA}$	1000h	#1	0/22
高温老化 High Temperature Operating		$T_A=55^{\circ}\text{C}$, $I_F=500\text{mA}$	1000h	#1	0/22
高温高湿老化 Temperature Humidity Operating		85°C , RH=85%, $I_F=500\text{mA}$	1000h	#1	0/22

b) 失效判定 Failure Criteria

判定 Criteria #	项目 Items	条件 Conditions	失效判定 Failure Criteria
#1	正向电压 Forward Voltage (V_F)	I_F	> 初始值×1.15 倍 > Initial value×1.1
	辐射功率 Radiation Power (Φ_e)	I_F	< 初始值×0.7 倍 < Initial value×0.7
	反向电流 Reverse Current (I_R)	$V_R=5V$	> 5uA > 5uA
#2	回流焊 Solderability	-	焊接面积<80% Less than 80% solder coverage

11、注意事项 Cautions

a) LED 灯珠硅树脂（硅胶透镜）操作注意事项

Handling precautions of Silicone Resin for LEDs



- 操作过程中，应尽量减少硅胶表面的机械应力。不得使用任何尖锐硬物刺穿或破损硅胶的密封层结构。During processing, mechanical stress on the surface should be minimized as much as possible. Sharp objects of all types should not be used to pierce the Silicone lens.
- 一般而言，LED 灯珠的夹取操作仅限于夹取灯珠两边。上述建议，同样适用于没有硅树脂密封产品，因为产品表面易被划伤。
In general, LEDs should only be handled from the side. By the way, this also applies to LEDs without a silicone sealant, since the surface can also become scratched.
- 在 SMT 贴片作业中，除了对硅树脂施加机械压力有限制外，诸如抓取灯珠吸嘴的形状是没有限制的。When populating boards in SMT production, there are basically no restrictions regarding the form of the pick and place nozzle, except that mechanical pressure on the surface of the Silicone lens must be prevented.
- 硅树脂不同于其他用于 LED 制造材料，在进行手动设备作业时，必须考虑注意以下所述情况事项。相比较于其他标准封装材料，硅树脂材料通常较软，表面更容易吸尘。如前所述，作业过程中对吸尘的敏感性增加需要特别小心。如果不能保证最低程度的污垢和灰尘颗粒，则必须在焊接器件后使用适当的清洁溶液涂在硅树脂表面进行清洁。
Silicone differs from materials conventionally used for the manufacturing of LEDs. These conditions must be considered during the handling of such devices. Compared to standard encapsulants, silicone is generally

softer, and the surface is more likely to attract dust. As mentioned previously, the increased sensitivity to dust requires special care during processing. In cases where a minimal level of dirt and dust particles cannot be guaranteed, a suitable cleaning solution must be applied to the surface after the soldering of components.

- 晶能建议使用异丙醇进行清洁。如果使用其他溶剂清洁，必须确保这些溶剂不会溶解封装或树脂。不建议使用超声波清洗。超声波清洗可能会损坏 LED。

LP suggests using isopropyl alcohol for cleaning. In case other solvents are used, it must be assured that these solvents do not dissolve the package or resin. Ultrasonic cleaning is not recommended. Ultrasonic cleaning may cause damage to the LED.

- 请不要将本产品二次模塑成型进其他树脂材料（环氧树脂、聚氨酯等），也不要再在密封空间内使用酸或硫磺材料处理本产品。

Please do not mold this product into another resin (epoxy, urethane, etc) and do not handle this product with acid or sulfur material in sealed space.

- 避免在器件硅树脂部分上留下指纹印记。

Avoid leaving fingerprints on silicone resin parts.

b) 使用注意事项 Precaution for Use

(1) 存储

为避免水分渗入，我们建议将 LED 灯存放在带干燥剂的干燥箱中。建议储存温度范围为 5°C~30°C，最大湿度为 RH50%。

Storage

To avoid the moisture penetration, we recommend storing LEDs in a dry box with a desiccant. The recommended storage temperature range is 5°C to 30°C and a maximum humidity of RH50%.

(2) 打开包装后注意事项

使用合适的 SMD 表面贴装技术非常重要；若 LED 器件在 SMD 贴片焊接工步中下压力过大导致透镜出现分离或分层式损伤，会严重影响封装芯片出光效率。

注意以下几点：

打开包装后的推荐存储条件如下

--密封/温度：5~30°C 湿度：小于 RH60%；

如果包装已打开超过 168H（MSL 3）或干燥剂颜色发生变化，器件应在 65±5°C 下干燥除湿 24 小时。

Use Precaution after Opening the Packaging

Use proper SMD techniques when the LED is to be soldered dipped as separation of the lens may affect the light output efficiency.

Pay attention to the following:

Recommend conditions after opening the package

-Sealing / Temperature: 5 ~ 30°C; Humidity: less than RH60%;

If the package has been opened more than 168H (MSL 3) or the color of the desiccant changes, components should be dried for 24hr at 65±5°C;

(3) 在焊接后冷却至正常温度的过程中，不要施加机械力或过度振动。

Do not apply mechanical force or excess vibration during the cooling process to normal temperature after soldering.

(4) 焊接后不要迅速冷却设备。

Do not rapidly cool device after soldering.

- (5) 器件不应安装在 PCB 的翘曲（非共面）部分。

Components should not be mounted on warped (non-coplanar) portion of PCB.

- (6) 在这里列出的产品不考虑放射性辐射性暴露问题。

Radioactive exposure is not considered for the products listed here in.

- (3) 该模块产品不能应用于任何类型的流体，如水、油、有机溶剂等等。如果必须进行清洗，建议使用异丙醇。

This device should not be used in any type of fluid such as water, oil, organic solvent and etc. When washing is required, IPA (Isopropyl Alcohol) should be used.

- (8) 本 LED 器件产品最大工作电流，应通过测量封装成品最高温度（Ts）是允许最大驱动电流确定“产品最大工作电流”。

When the LEDs are in operation the maximum current should be decided after measuring the package temperature.

- (9) LED 必须存放在干净的环境中。我们建议将 LED 储存在充满氮气的容器中。

LEDs must be stored in a clean environment. We recommend LEDs store in nitrogen-filled container.

- (10) 在灯具制造中使用的材料释放出的挥发性有机化合物（VOCs）可以穿透 LED 的硅酮密封材料，长时间暴露在热和光子能下时会变色（也即硅胶黄变）。结果可能导致灯具的光输出严重损失。了解灯具结构中所选材料的特性有助于预防这些问题。

VOCs (Volatile organic compounds) emitted from materials used in the construction of fixtures can penetrate silicone encapsulants of LEDs and discolor when exposed to heat and photonic energy. The result can be a significant loss of light output from the fixture. Knowledge of the properties of the materials selected to be used in the construction of fixtures can help prevent these issues.

- (11) 粘结或固定 LED 器件时，请不要使用具有有机挥发性气体粘结剂或焊接剂材料。

Attaching LEDs, do not use adhesives that outgas organic vapor.

- (12) 驱动电路必须设计成仅在接通或断开时允许正向电压。如果反向电压施加在 LED 上，会产生迁移，导致 LED 损坏。

The driving circuit must be designed to allow forward voltage only when it is ON or OFF. If the reverse voltage is applied to LED, migration can be generated resulting in LED damage.

- (13) LED 器件对静电放电（ESD）和电气过应力（EOS）两种伤害非常敏感。以下是晶能提供一些尽可能减少影响建议：

LEDs are sensitive to Electro-Static Discharge (ESD) and Electrical Over Stress (EOS). Below is a list of suggestions that Lattice Power purposes to minimize these effects.

a. ESD (静电放电)

ESD (Electro Static Discharge)

静电放电（ESD）是指当两个物体接触时释放出的静电。虽然大多数 ESD 事件被认为是无害的，但在

许多工业环境中，ESD 在生产和存储过程中可能是一个代价高昂的问题。ESD 对 LED 的损坏可能会导致产品显示出不寻常的特性，例如：

Electrostatic discharge (ESD) is defined as the release of static electricity when two objects come into contact. While most ESD events are considered harmless, it can be an expensive problem in many industrial environments during production and storage. The damage from ESD to LEDs may cause the product to demonstrate unusual characteristics such as:

- 反向漏电流的增加降低了开启电压；
- Increase in reverse leakage current lowered turn-on voltage;
- 低电流下 LED 的异常发射；
- Abnormal emissions from the LED at low current

以下建议有助于将发生 ESD 事件的可能性降至最低：

The following recommendations are suggested to help minimize the potential for an ESD event.

工作区建议：

One or more recommended work area suggestions:

- 离子风扇配置；
- Ionizing fan setup
- 由导电材料制成的 ESD 桌子/架子垫；
- ESD table/shelf mat made of conductive materials
- ESD 安全存储容器
- ESD safe storage containers

工作人员建议：

One or more personnel suggestion options:

- 防静电腕带；
- Antistatic wrist-strap
- 防静电鞋；
- Antistatic material shoes
- 防静电服；
- Antistatic clothes

环境控制：

Environmental controls:

- 湿度控制(干燥环境让 ESD 更加糟糕)
- Humidity control (ESD gets worse in a dry environment)

b. EOS (电气过应力)

EOS (Electrical Over Stress)

电气过应力 (EOS) 是指当电子设备受到超过设备最大规格限制的电流或电压时可能发生的损坏。EOS 事件的影响可以通过产品性能观察到，例如：

Electrical Over-Stress (EOS) is defined as damage that may occur when an electronic device is subjected to a current or voltage that is beyond the maximum specification limits of the device. The effects from an EOS

event can be noticed through product performance like:

-LED 封装性能的变化；（如果损伤发生在 Bonding 区域，因为 LED 是完全密封的，所以 Bonding 区域存在开裂风险，LED 灯珠呈现闪烁点亮状况，出严重的性能下降。）

-Changes to the performance of the LED package (If the damage is around the bond pad area and since the package is completely encapsulated the package may turn on but flicker show severe performance degradation.)

-部分器件完全失效导致的灯具光输出异常；

-Changes to the light output of the luminaire from component failure

-器件在模组中未在确定的驱动功率下运行工作（部分灯珠器件异常亮或异常暗）；

-Components on the board not operating at determined drive power

由于整个电路中的电路电压和电流环流过程发生变化，最终导致整个模组的性能失效，就像涓滴效应失败。由于故障模式调查已被变化，无法预测暴露在电气过应力下的每个 LED 的故障模式，但有一些共同的迹象表明已发生 EOS 事件，例如：

Failure of performance from entire fixture due to changes in circuit voltage and current across total circuit causing trickle down failures. It is impossible to predict the failure mode of every LED exposed to electrical over stress as the failure modes have been investigated to vary, but there are some common signs that will indicate an EOS event has occurred:

-可能会注意到连接线损坏（看起来类似于熔断的保险丝）；

-Damaged may be noticed to the bond wires (appearing similar to a blown fuse)

-封装的 LED 芯片出光面 Bonding Pad 或导电 Pad 有明显损伤（通过显微镜观察时，可以发现焊盘周围有阴影或焦黑状）；

-Damage to the bond pads located on the emission surface of the LED package (shadowing can be noticed around the bond pads while viewing through a microscope)

-这种损伤通常是由于 EOS 事件中产生的热应力引起的；

-This damage usually appears due to the thermal stress produced during the EOS event.

c. 为了帮助减少 EOS 事件造成的损伤，晶能建议应用如下：

To help minimize the damage from an EOS event Lattice Power recommends utilizing:

-电涌保护电路；

-A surge protection circuit;

-额定值适当的过电压保护装置；

-An appropriately rated over voltage protection device;

-限流装置。

-A current limiting device.